

# HIGH-SPEED DC CIRCUIT BREAKERS FOR FIXED INSTALLATIONS (IEEE)

Type **UR**

DC TRACTION SUBSTATIONS

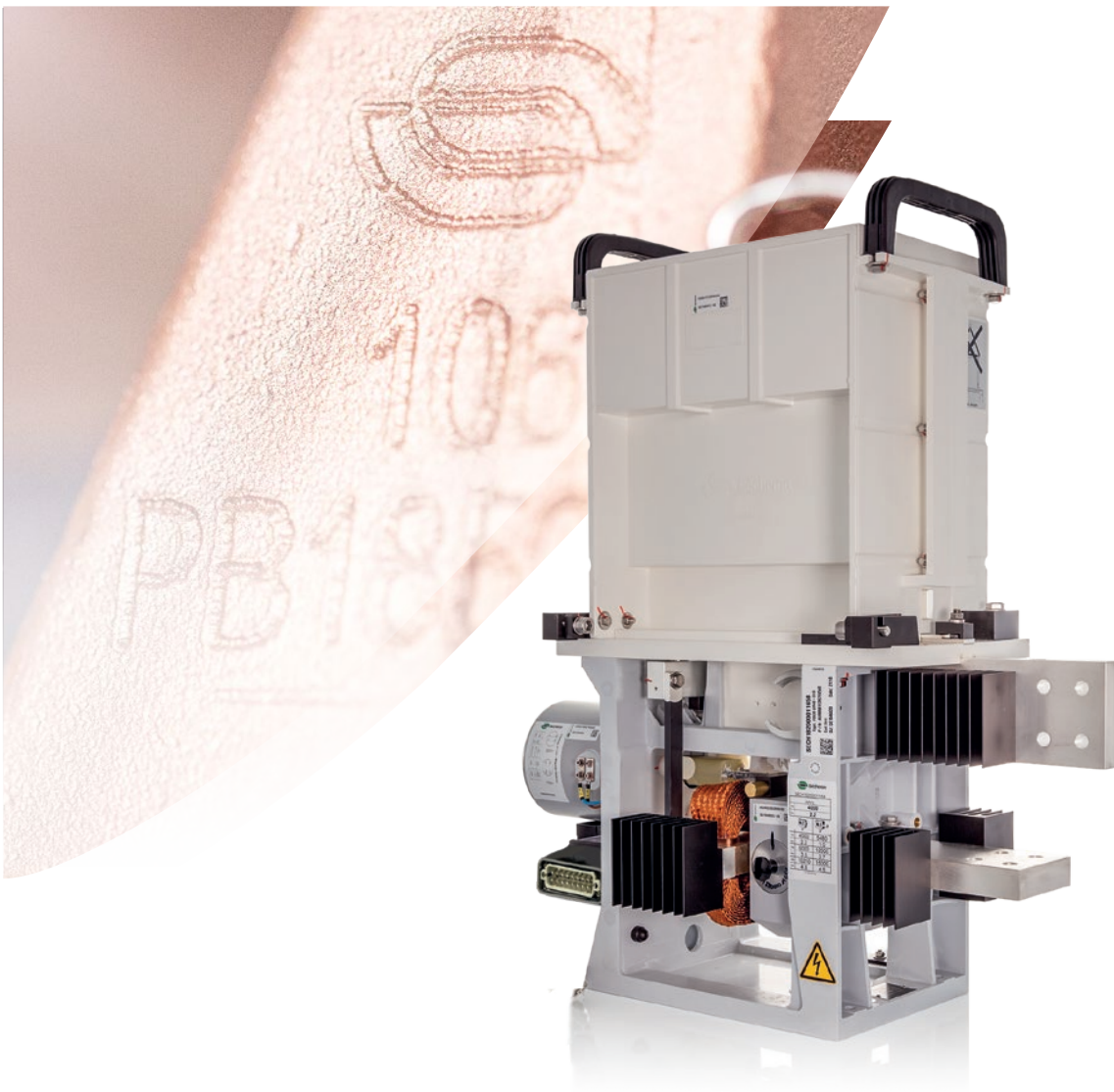

# GENERAL INFORMATION

The **UR** range of DC circuit breakers has achieved worldwide acceptance as a well proven design for use in fixed installations. It has been regularly upgraded and adapted to new standard requirements and for different applications over the years, continuously improving the level of performance and functionality. This has led to an impressive service track record throughout the world for the UR product range.

Designed according to IEEE C37.14 and IEEE C.37.16, the UR range can be used for Light Rail and Heavy Rail Transit Systems on the North American territory. Combining a compact design with a high making and breaking capacity, the UR range, with its low number of parts also guarantees high reliability and low maintenance requirements.

## TYPICAL APPLICATION (DC TRACTION POWER SUBSTATION)

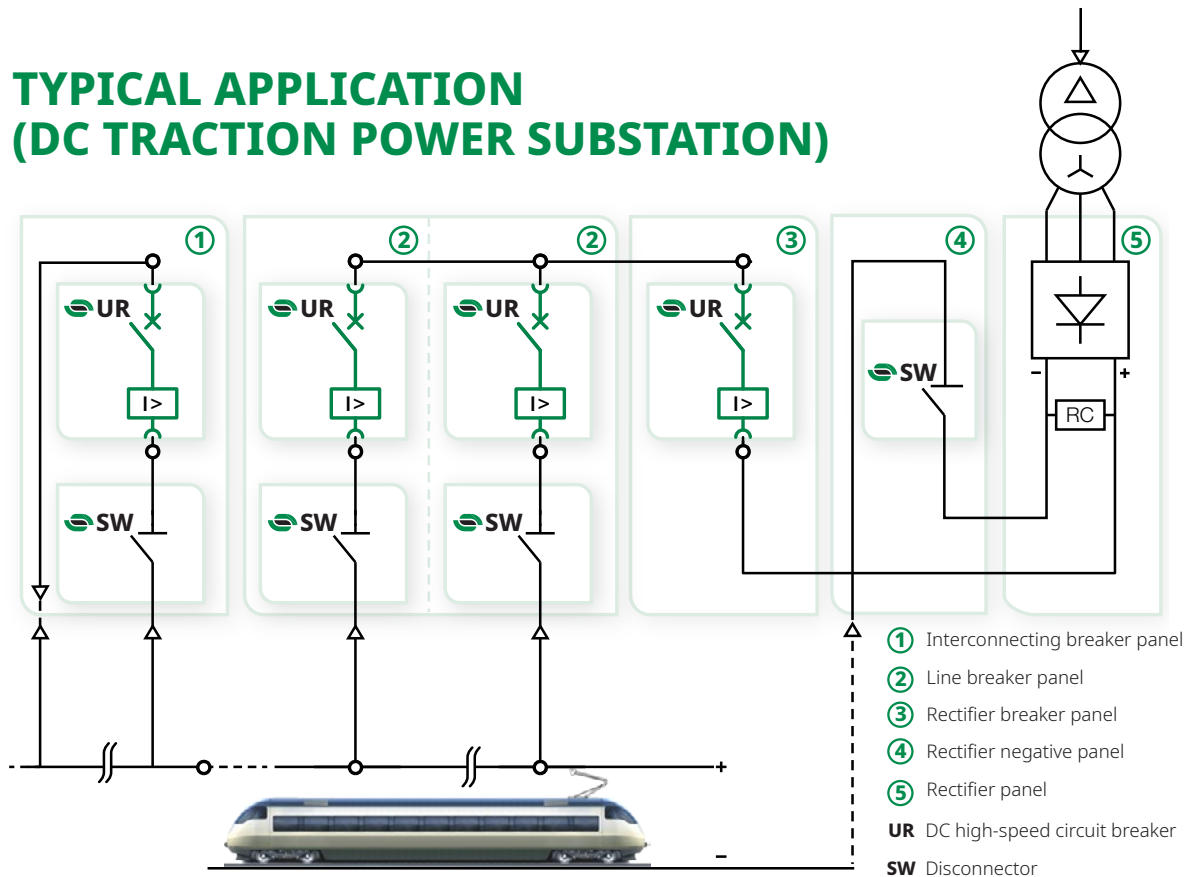

## MAIN FEATURES

- Thermal current up to 8,000 A
- Rated voltage 800 V<sub>DC</sub> and 1,600 V<sub>DC</sub> (1,200 V<sub>DC</sub> for UR80)
- Indoor installation
- Bidirectional or unidirectional overcurrent release
- Trip-free direct acting device
- Limited maximum arc voltage
- Electro-magnetic closing with electric or magnetic holding
- Reference standards: IEEE C37.14 and IEEE C37.16
- Also available according to EN 50123-1/-2, IEC 61992-1/-2 standards (refer to our specific SG101001BEN brochure)
- Insulation material according to EN 45545-2



# MAIN BENEFITS

- ✓ Safe with a high insulation level.
- ✓ Very low maintenance requirements with high electrical and mechanical dururances.
- ✓ Simple design with few moving parts resulting in high reliability.
- ✓ High rated short circuit making and breaking capacity.
- ✓ A large number of different options to match the various application requirements.
- ✓ Proven design with worldwide experience and acceptance.

## PRODUCT RANGE

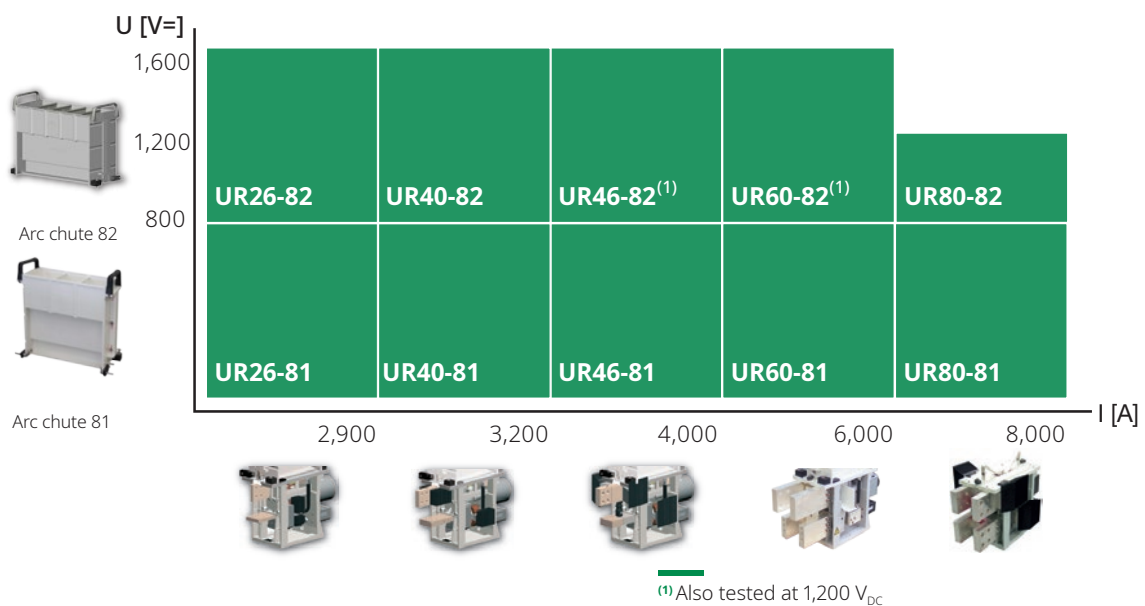

<sup>(1)</sup> Also tested at 1,200 V<sub>DC</sub>

## BREAKING CURRENT PARAMETERS

### BREAKING CURRENT PARAMETERS

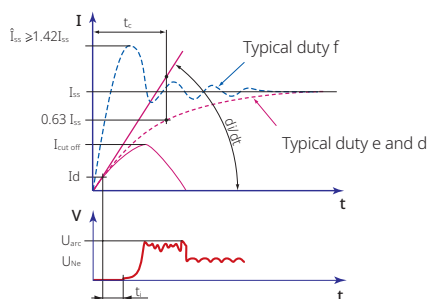

- $I_{ss}$  = Prospective sustained short-circuit current
- $\hat{I}_{ss}$  = Peak of  $I_{ss}$
- $di/dt$  = Initial current rate of rise
- $I_d$  = Setting of maximum current release
- $I_{cut\ off}$  = Cut-off current
- $t_c$  = Time-constant of the circuit
- $t_i$  = Opening time
- $U_{arc}$  = Maximum arc voltage
- $U_{Ne}$  = Rated operational voltage

### OPENING TIME $T_I$

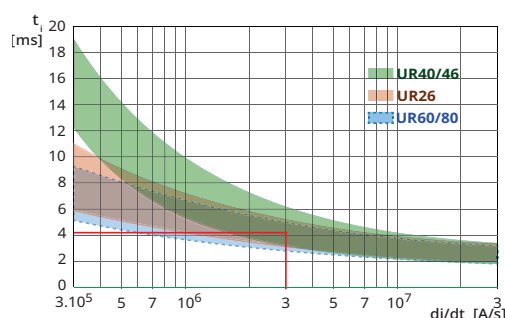

Relationship between opening time  $t_i$  and the initial rate of rise of current  $di/dt$  for direct instantaneous overcurrent release.

Example for a  $di/dt$  of  $3 \times 10^6$  A/S:

- for UR26:  $t_i \sim 4.3$  ms,
- for UR60/80:  $t_i \sim 4.1$  ms.

**Note:** for a shorter opening time on low  $di/dt$ , the "indirect release" (shunt trip) option can be used (refer to "Options" section page 9).

# DATA FOR PRODUCT SELECTION

Symbol	Unit	UR26	UR40	UR46	UR60	UR80
<b>MAIN HIGH VOLTAGE CIRCUIT</b>						
Frame size current		2,150	3,200	4,000	6,000	8,000
Rated voltage						
- arc chute type 81	$U_{Ne}$ [V <sub>DC</sub> ]	800	800	800	800	800
- arc chute type 82		1,600	1,600	1,600	1,600	1,200
Rated continuous current <sup>(1)</sup>						
- IEEE	$U_{Nm}$ [V <sub>DC</sub> ]	2,150	3,200	4,000	6,000	8,000
- EN 50123 / IEC 61992 (for information only)		2,600	4,000	4,600	6,000	8,000
Rated peak & sustained short-circuit current for test a	[kA/kA]					
- at 800 V <sub>DC</sub> <sup>(2)</sup>		200/120	200/120	200/120	200/120	200/120
- at 1,200 V <sub>DC</sub> <sup>(2)</sup>		-	-	132/80	132/80	132/80
- at 1,600 V <sub>DC</sub> <sup>(2)</sup>		100/60	100/60	100/60	100/60	-
Short circuit value for tests b/c/d	[kA]					
- at 800 V <sub>DC</sub> <sup>(2)</sup> (time constant 210 ms)				52.6/31.2/17.9		
- at 1,200 V <sub>DC</sub> <sup>(2)</sup> (time constant 210 ms)		-	-	49.0/35.3/22.6		
- at 1,600 V <sub>DC</sub> <sup>(2)</sup> (time constant 66 ms)			44.3/35.0/ 25.0			-
Peak & rated short-time current	[kA]	-	-	-	75/50	75/50
Overcurrent trip range (bidirectional) <sup>(3)</sup>	[kA]	1.4-8.0	2-15	2-15	6-18	8-24
Reverse overcurrent trip value (unidirectional)	[kA]	-	-	-	6 or 4-10	6 or 4-10
Power frequency withstand voltage (IEEE) (60 Hz, 1 min) <sup>(4)</sup>	[kV]					
- arc chute type 81		12	12	12	12	12
- arc chute type 82		12	12	12	12	12

<sup>(1)</sup> At  $T_{amb} = +40^{\circ}\text{C}$  and tested with high voltage connections according to standard IEEE C37.14 -2015. <sup>(2)</sup> According to IEEE C37.14-2015. <sup>(3)</sup> For range selection, refer to the table page 6. <sup>(4)</sup> Values applicable for factory tests on serial products.

## LOW VOLTAGE CIRCUIT

### Control circuit

Nominal supply voltage <sup>(5)</sup>	$U_n$ [V <sub>DC</sub> ]	110, 125				
Range of voltage		[0.7 - 1.25] $U_n$			[0.8 - 1.1] $U_n$	
Closing power <sup>(6)</sup>	[W]/[S]	1,300/1 (E)   1,300/1 (M) <sup>(6)</sup>			3,200/1 (E)   2,600/1 (M)	
Holding power <sup>(7)</sup>	[W]	2.3 (E)   0 (M)			30 (E)   0 (M)	
Opening power <sup>(7)</sup>	[W]/[S]	25/1 (M)			700/1 (M)	
Mechanical opening time on opening order <sup>(7) (8)</sup>	$t_o$ [ms]	15 - 30 (E)   5 - 75 (M)			15 - 30 (E)   5 - 75 (M)	
Mechanical closing time <sup>(7) (8)</sup>	$t_c$ [ms]	~ 150 (E)(M)			~ 150 (E)(M)	

<sup>(5)</sup> The breaker can also be controlled with a rectified AC control voltage. <sup>(6)</sup> (E) E-type: Electric holding | (M) M-type: Magnetic holding. <sup>(7)</sup> At  $U_n$  and  $T_{amb} = +20^{\circ}\text{C}$ . <sup>(8)</sup> Starting when the signal is received by the coil.

### Auxiliary contacts

Type of contacts (refer to definition on page 10)		Potential free (PF) or change-over (CO)				
Number of auxiliary contacts		5a + 5b				
Rated voltage	[V <sub>DC</sub> ]	24 to 220				
Conventional thermal current	$I_{th}$ [A]	10				
Switching categories according to EN 60947 (silver contacts)	[A]	AC-15 230 V <sub>AC</sub> 1.0 A				
	[A]	DC-13 110 V <sub>DC</sub> 0.5 A				
Minimum let-through current at 24 V <sub>DC</sub> <sup>(9)</sup>	[mA]	≥ 10				

<sup>(9)</sup> For a dry and clean environment.

### Low voltage interface

Type of connection <sup>(10)</sup>		Harting type Han® 32 EE				
------------------------------------	--	-------------------------	--	--	--	--

<sup>(10)</sup> For mobile connector information refer to page 9.

## OPERATING CONDITIONS

Installation		Indoor				
Altitude	[m]	≤ 2,000 <sup>(11)</sup>				
Working ambient temperature <sup>(12)</sup>	$T_{amb}$ [°C]	- 25 to + 40				
Humidity		Class 5k2				
Minimum mechanical durability	N Operations	4x50,000	8x25,000	8x25,000	4x20,000	4x20,000

<sup>(11)</sup> For altitude >2,000 m, please contact Sécheron. <sup>(12)</sup> For ambient temperature outside of the range, please contact Secheron.

# DIRECT OVERCURRENT RELEASE SELECTION

## AVAILABLE TRIPPING DEVICES

Available setting ranges (in kA) with their corresponding codification

UR26	UR40	UR46	UR60	UR80	type	Designation code <sup>(1)</sup>	
						Standard	Options
1.4 - 2.7	-	-	-	-	DV1	A	
2.0 - 5.0	2.0 - 5.0	2.0 - 5.0	-	-	DV2		B
2.0 - 8.0	2.0 - 8.0	2.0 - 8.0	-	-	DS1	D	
-	4.0 - 15.0	4.0 - 15.0	-	-	DS2	F	
-	4.0 - 10.0	4.0 - 10.0	-	-	DV2		G
-	-	-	6.0 - 10.0	-		J	
-	-	-	10.0 - 14.0	-		K	
-	-	-	14.0 - 18.0	-		L	
-	-	-	-	8.0 - 14.0		N	
-	-	-	-	14.0 - 18.0		O	
-	-	-	-	18.0 - 24.0		P	
-	-	-	6.0 <sup>(2)</sup>	6.0 <sup>(2)</sup>			U
-	-	-	6.0 <sup>(3)</sup>	6.0 <sup>(3)</sup>		W	
-	-	-	4.0 - 10.0 <sup>(2)</sup>	4.0 - 10.0 <sup>(2)</sup>			X
-	-	-	4.0 - 10.0 <sup>(3)</sup>	4.0 - 10.0 <sup>(3)</sup>			Y

<sup>(1)</sup> For selection page 16.

<sup>(2)</sup> Unidirectional overcurrent release. Tripping direction A → B.  $\hat{I}_{New}/I_{New} = 75/50$  kA.

<sup>(3)</sup> Unidirectional overcurrent release. Tripping direction B → A.  $\hat{I}_{New}/I_{New} = 75/50$  kA.

## AVAILABLE TRIPPING DEVICES

### UR26/40/46

Standard tripping device



DS tripping device



DV tripping device



Setting of maximum current release

### UR60/80

Standard tripping device



Tripping device

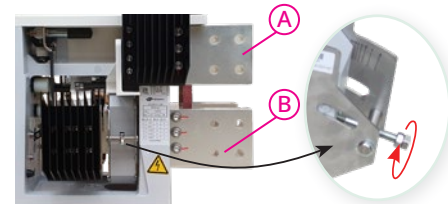

Setting of maximum current release

### Specific configurations for rectifier circuit breakers



Tripping device

For unidirectional circuit-breakers, different configurations can be selected based on the breaker's HV busbar (A or B) connected to the rectifier's output.

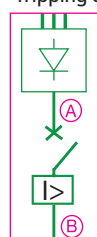

Unidirectional breaker HV connection configuration	Designation code	
	standard Code W, Y	Optional Code U, X
No trip direction with $\hat{I}_{New}/I_{New} = 75/50$ kA (250 ms)	A → B	B → A
Trip direction with trip setting 6 kA	B → A	A → B

# INFORMATION FOR PRODUCT INTEGRATION

## MAIN DIMENSIONS FOR UR26/40/46

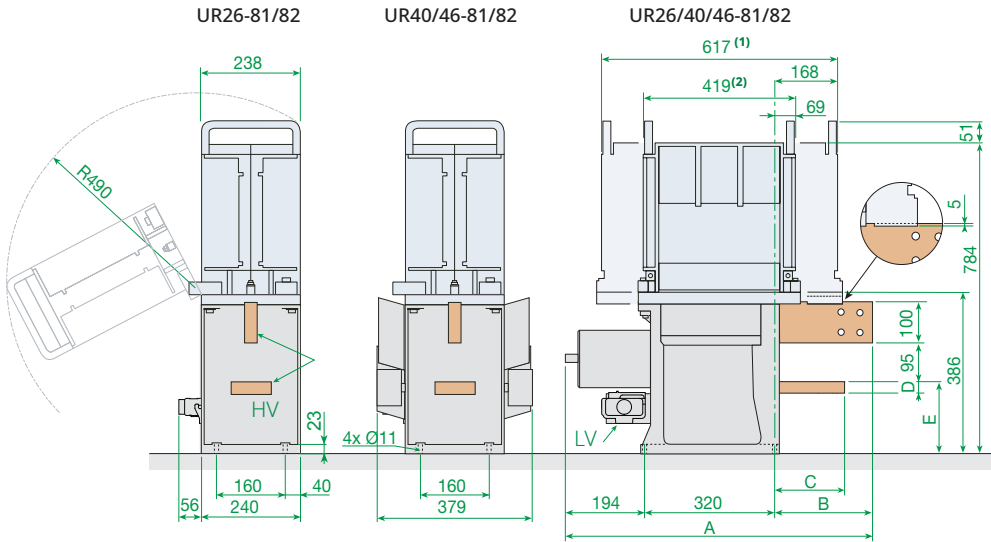

Dimensions without tolerances are indicative. All dimensions are in mm. The maximum allowed flatness deviation of the support frame is 0.5 mm.

### HV connections for UR26/40/46

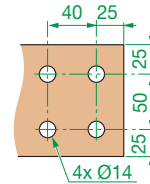

- (1) Arc chute 82
- (2) Arc chute 81

## MAIN DIMENSIONS FOR UR60/80

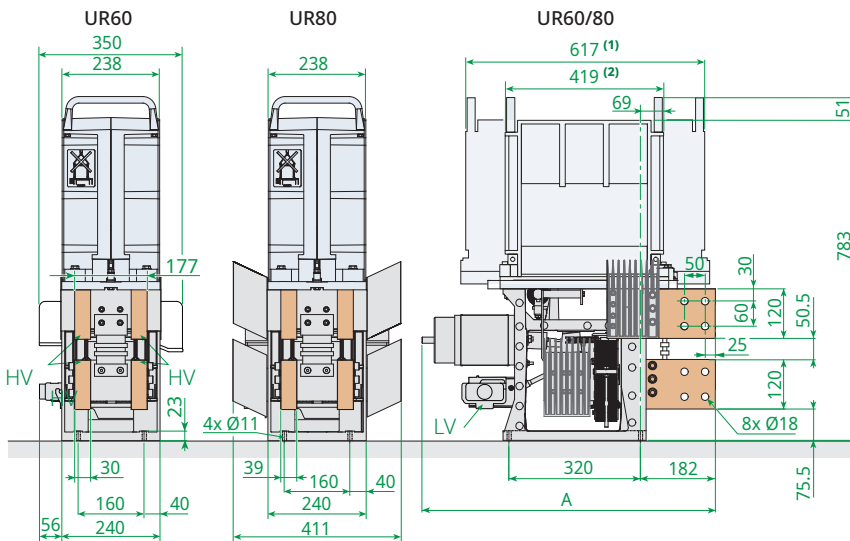

Dimension A [mm]	
<b>Standard closing device <sup>(3)</sup></b>	
Electric holding	718
Magnetic holding	756
<b>Specific closing device <sup>(4)</sup></b>	
Electric holding	748
Magnetic holding	748

- (1) Arc chute 82
- (2) Arc chute 81
- (3) All breaker configurations excepted optional configuration of unidirectional breaker.
- (4) Optional configuration of unidirectional breaker

Dimensions [mm]	UR26	UR40	UR46
(A)	645	760	760
(B)	131	246	246
(C)	131	176	176
(D)	20	30	40
(E)	176	176	177

## WEIGHTS

	Weights <sup>(1)</sup> [kg] ± 5%				
	UR26	UR40	UR46	UR60	UR80
With arc chute 81	77	98	110	139	150
With arc chute 82	87	108	120	149	160

(1) Weights for standard circuit breaker without any option.

## INSULATION DISTANCES FOR UR26/40/46/60/80

### UR..81/82S

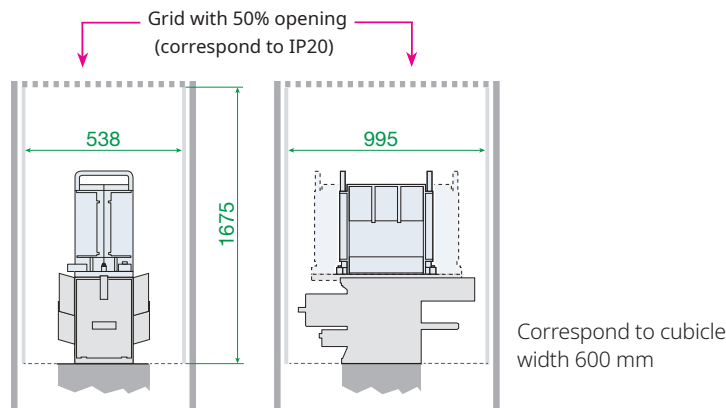

The DC circuit-breakers have been homologated according to IEEE C37 in cubicle's configurations with insulation panels on the area where dimensions are indicated in the below's representation and for short-circuit conditions as defined page 4.

For particular cubicle configuration and short-circuit conditions, please contact Sécheron.

## ARC CHUTE INSTALLATION

### Opening to LV connector side

UR26/40/46 (arc chutes 81/82)  
UR60/80 (arc chute 82)

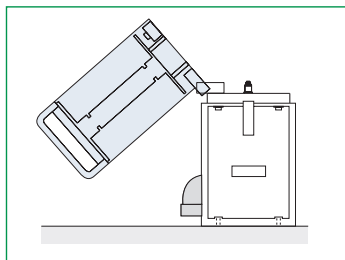

### Opening to LV connector opposite side

UR26/40/46 (arc chutes 81/82)  
UR60/80 (arc chute 82)

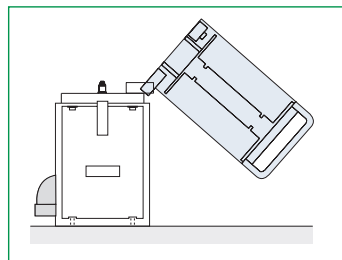

### Vertical removal

UR60/80 (arc chute 81)

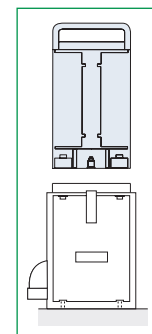

## LOW VOLTAGE CONTROL DIAGRAM

### ELECTRIC HOLDING

#### E-TYPE

- The circuit breaker remains closed with a **reduced "holding" current**. To open the circuit breaker the holding current is cut-off.
- With **E-type** closing device, the circuit breaker cannot remain closed if the low voltage supply is lost.

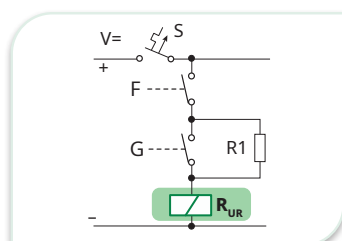

### MAGNETIC HOLDING

#### M-TYPE

- The circuit breaker remains closed **without any control current**. To open the circuit breaker it is necessary to reverse the polarity of the current flowing through the closing coil.
- With the **M-type** closing device, the circuit breaker remains closed when the low voltage supply is lost. It requires the control voltage to be present to open.

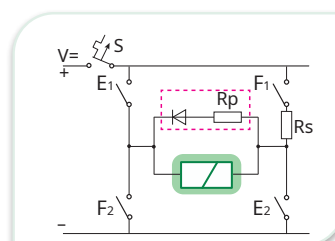

The **UR** range is equipped with a solenoid coil to perform the usual closing and opening operations. Two different types of closing devices are available: with electric holding (E-type) or with magnetic holding (M-type).

### Legend

- Customer scope
- Sécheron scope
- Only for UR26 to UR46

- E, F : control contacts
- F, G : control contacts
- R1 : holding resistor
- Rs : serial resistor
- Rp : parallel resistor
- S : automatic circuit breaker



### TYPICAL VALUE FOR CLOSING COILS - UR26/40/46

Coil characteristics													
U <sub>n</sub>	Closing pulse 0.5 to 1s				holding E-type				opening pulse M-type 0,5 to 1s				
	I <sub>nom</sub>	I <sub>min</sub> E	I <sub>min</sub> M	I <sub>max</sub>	R1	I <sub>nom</sub>	I <sub>min</sub>	I <sub>max</sub>	Rs	Rp	I <sub>nom</sub>	I <sub>min</sub>	I <sub>max</sub>
[V <sub>DC</sub> ]	[A]	[A]	[A]	[A]	[Ω]	[A]	[A]	[A]	[Ω]	[Ω]	[A]	[A]	[A]
110	11.7	6.3	7.0	19.9	210	0.5	0.4	0.6	40	20	1.6	1.0	2.3
125	10.5	5.6	6.3	17.8	272	0.4	0.3	0.6	52	26	1.4	0.9	2.0

The breaker can also be controlled with a rectified AC control voltage.

### TYPICAL VALUE FOR CLOSING COILS - UR60/80

Coil characteristics														
U <sub>n</sub>	E-type							M-type						
	Closing pulse 0.5 to 1s				holding			Closing pulse 0.5 to 1s			opening pulse			
	I <sub>nom</sub>	I <sub>min</sub> E	I <sub>max</sub>	R1 <sub>nom</sub>	I <sub>nom</sub> <sup>(1)</sup>	I <sub>min</sub> <sup>(1)</sup>	I <sub>max</sub> <sup>(1)</sup>	I <sub>nom</sub>	I <sub>min</sub> M	I <sub>max</sub>	Rs <sub>nom</sub>	I <sub>nom</sub>	I <sub>min</sub>	I <sub>max</sub>
[V <sub>DC</sub> ]	[A]	[A]	[A]	[Ω]	[A]	[A]	[A]	[A]	[A]	[A]	[Ω]	[A]	[A]	[A]
110	25.0	16.6	33.2	56	1.8	1.5	2.0	21.3	13.5	28.3	15	5.4	4.1	6.3
125	22.5	14.9	29.9	75	1.6	1.3	1.7	18.4	11.7	24.5	18	5.0	3.8	5.8

<sup>(1)</sup>With selected economy resistor

The breaker can also be controlled with a rectified AC control voltage.

## LOW VOLTAGE CONTROL DIAGRAM FOR HARTING TYPE HAN®32 EE CONNECTOR (STANDARD)

The following wiring schemes represent the low voltage connector pins assignment in function of the selected connectors and the configuration chosen for standard or optional functions.

Only the pins related to your selected configuration page 12 will be wired according to the below's pin assignment. The connector will be delivered with all 32 pins even if not all wired.

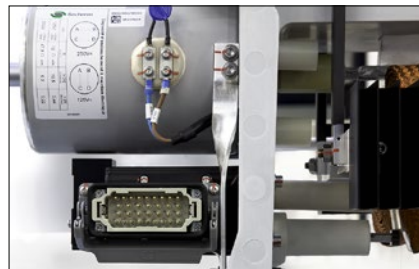

Harting type HAN® 32 EE (Standard)

#### AUXILIARY CONTACTS (SWITCH PF)

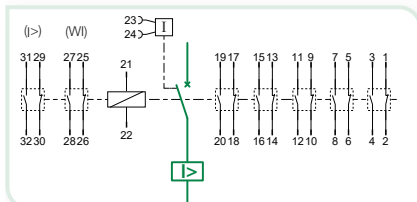

#### AUXILIARY CONTACTS (SWITCH CO)

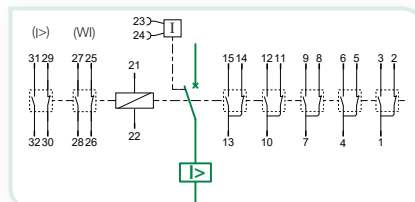

#### Legend

	Circuit breaker main contact
	Direct overcurrent release
	Low voltage connector interface (male pin)
	1a+1b - Switch PF
	1a+1b - Switch CO
	Indirect overcurrent release
	Circuit breaker closing coil
	Wear indicator switch (option)
	Overcurrent release detector switch (option)

#### Note:

- Low voltage connectors are delivered with all pins mounted, even if not all wired.



- Indirect release coils BIM6 & BIM8 are connected to a low voltage connector while BIM5 & BIM7 are connected to a terminal block (refer to page 10).



# OPTIONS

(SUBJECT TO ADDITIONAL COSTS)

## MOBILE CONNECTOR - UR26/40/46/60/80

Auxiliary switches			Control voltage	Fixed connector type	Mobile connector (without cable)				
Device	Number	Type			Number of pin (delivered with connector)		Cable gland	Sécheron's number	Connector
					Size 2.5 mm <sup>2</sup>	Size 1.5 mm <sup>2</sup>			
UR26/40/46 (with or without ECO-Drive) with options (M) or (I>) and □	5a+5b	PF	110, 125 V <sub>DC</sub>	Harting HAN® 32 EE	2	30	M32	SG104063R10100	
UR60/80 (without ECO-Drive)	5a + 5b	PF	110, 125 V <sub>DC</sub>	Harting HAN® 32 EE	2	30	M32	SG104063R10100	

The breaker can also be controlled with a rectified AC control voltage.

**Note:** crimping tools are not in the scope of Sécheron

## ECO-DRIVE INTEGRATED CONTROL MODULE UR26/40/46



ECO-Drive is a compact control module integrated with UR circuit breakers, to manage closing-holding sequences with electric control. ECO-Drive is set on the UR breaker's closing device.

## MAIN BENEFITS

- ✓ No need of additional hardware to control the breaker.
- ✓ Compact integration.
- ✓ Reduction of overall installation costs.
- ✓ Reduction of operational costs with lower power consumption.
- ✓ Reduction of the risks to damage the closing coil.
- ✓ Full compliance with EN 50121-3-2 standards for EMC
- ✓ Full compliance with EN 50155 § 5.1.1.2 class S2 (short interruption of voltage supply).
- ✓ Full compliance with EN 50155 § 5.1.3 class C1 (supply change over).

- Available for UR26/40/46  
- Available for closing device with E-type holding

## LOW VOLTAGE WIRING DIAGRAM HARTING CONNECTOR

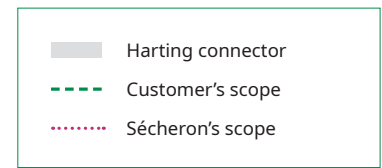
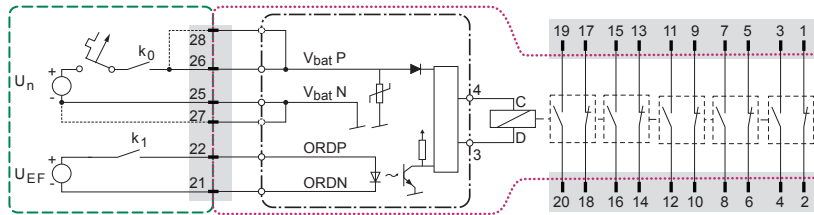

**Note:** Certain option combination might not be compatible. Please check with Sécheron.

## TECHNICAL DATA

### Control circuit

Nominal supply voltage <sup>(1)</sup>	$U_N$ [V <sub>DC</sub> ]	110
Nominal control voltage <sup>(1)</sup>	$U_{EF}$ [V <sub>DC</sub> ]	110
Range of voltage		[ 0.7 - 1.25 ] $U_n$
Idle (standby) power	[W]	< 1.6
Nominal closing power <sup>(2)</sup>	$P_c$ [W]/[s]	1,300/0.5
Nominal holding power <sup>(2)</sup>	[W]	< 8
Nominal opening power <sup>(2)</sup>	[W]	< 1.6
Mechanical opening time on opening order <sup>(3)</sup>	[ms]	15-30
Mechanical closing time on closing order <sup>(2)(3)</sup>	$T_c$ [ms]	~150

<sup>(1)</sup> Control voltage  $U_{EF}$  and supply voltage  $U_n$  can be different

<sup>(2)</sup> At  $U_n$  and  $T_{amb} = +20^\circ\text{C}$

<sup>(3)</sup> Starting when the signal is received by the coil

## BIM INDIRECT RELEASE (SHUNT TRIP) WITH INTEGRATED MANUAL RELEASE

		Opening time	Control mode
UR26/40/46	BIM5	4 - 6 ms	CID-3 <sup>(1)</sup>
	BIM6	12 - 19 ms	Direct battery 77-140 V <sub>DC</sub>
UR60/80	BIM7	4 - 6 ms	CID-3 <sup>(1)</sup>
	BIM8	12 - 19 ms	Direct battery 77-140 V <sub>DC</sub>

The indirect release enables to shorten the opening time when required by specific application. The choice of the relevant type has to be validated by Sécheron prior quoting. This device can also be manually activated.

<sup>(1)</sup> Not included in the DC circuit breaker - To be ordered separately

### BIM5 & BIM6 - UR26/40/46

The terminal block allows the connection between 2.5 mm<sup>2</sup> cables from the BIM5 and 2.5 mm<sup>2</sup> cables from the battery and 6 mm<sup>2</sup> cables from the CID-3. BIM6 is directly connected to the low voltage connector.

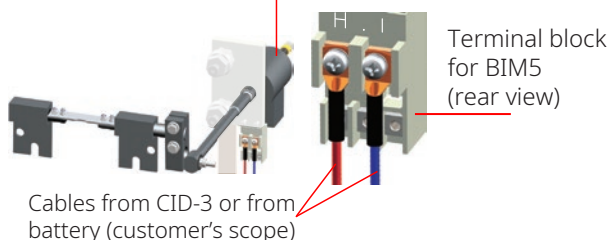
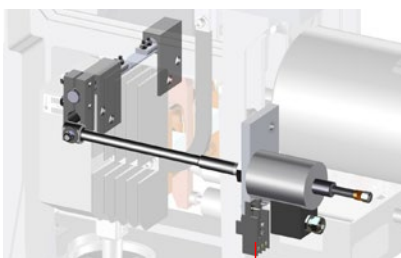

### BIM7 & BIM8 - UR60/80

The terminal block allows the connection between 2.5 mm<sup>2</sup> cables from the BIM7 and 2.5 mm<sup>2</sup> cables from the battery and 6 mm<sup>2</sup> cables from the CID-3. BIM8 is directly connected to the low voltage connector.

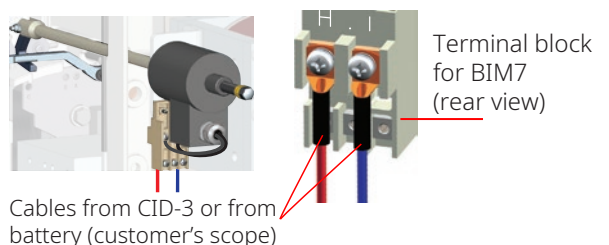
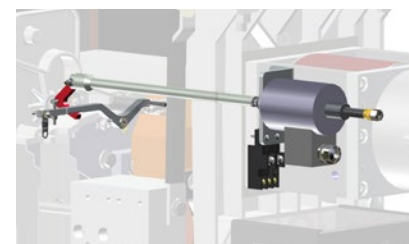

## MANUAL RELEASE

Manual releases are safety devices designed to guarantee that the breaker is in OPEN position so as to access the breaker's panel -e.g. for maintenance. The vertical release is automatically actuated while

withdrawing from the panel the trolley on which the breaker is installed. The horizontal release must be manually actuated from the front side of the panel door before opening it.

### // UR26/40/46

vertical release

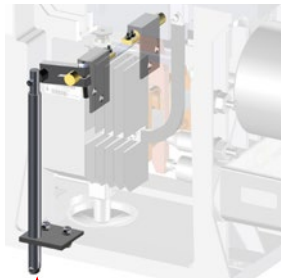

actuation

horizontal release

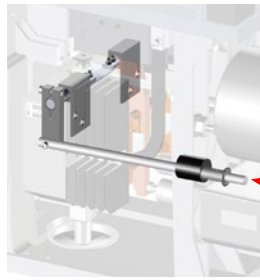

actuation

### // UR60/80

vertical release



actuation

horizontal release

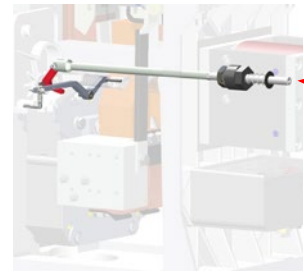

actuation

## MANUAL CLOSING DEVICE

### // UR26/40/46

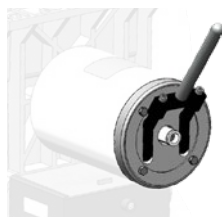

### // UR60/80

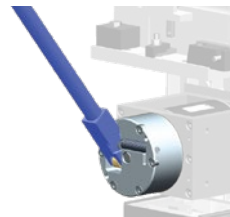

The manual closing device, mainly used for maintenance operations, enables to close and open the circuit breaker without low voltage supply and under no load.

## CONTACT WEAR INDICATOR (WI) OR OVERCURRENT RELEASE DETECTOR (I>) UR26/40/46

Installed on the rear side of the circuit breaker closing device, these options monitor the position of a rod linked to the breaker's moving contact, which rod actuates a micro-switch.

Based on the selected configuration the detector informs about:

- the reaching of the wear limit of the main contacts of the circuit breaker: function "contact wear indicator".
- the tripping of the circuit breaker through the overcurrent release: function "overcurrent release detector". These two functions cannot be selected together.

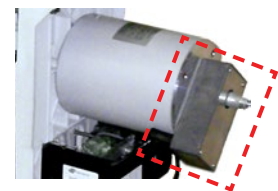
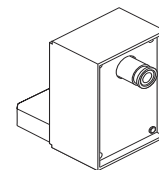

Contact wear indicator

## POSITION INDICATOR - UR26/40/46/60/80

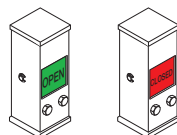

A mechanical position indicator actuated through a rod linked to the circuit-breaker moving contact gives the position of the breaker.

# DESIGNATION CODE FOR ORDERING

- Be sure to establish the designation code from our latest version of the brochure by downloading it from our website "www.secheron.com".
- Be careful to write down the complete alphanumeric designation code with 22 characters when placing your order.
- The customer shall write down the setting of maximum current release value (Id) in its order form.
- For technical reasons some variants and options indicated in the designation code might not be combined.
- The bold part of this designation code defines the device type, and the complete designation defines the identification number of the product, as displayed on the identification plate attached to the product.

**Example of customer's choice:** **UR 40 81 S 1 E E 0 F 0 A C 0 0 0 0 0 S B**  
 Line: 10 11 12 13 14 15 16 17 18 19 20 21 22 23 24 25 26 27 28

## DESIGNATION CODE

Line	Description	Designation		Customer's choice
		standard	options	
10	Product type	UR	<b>UR</b>	<b>UR</b>
11	Conventional free air thermal current	2,150 A 3,200 A 4,000 A 6,000 A 8,000 A	<b>26</b> <b>40</b> <b>46</b> <b>60</b> <b>80</b>	
12	Rated operational voltage	800 V 1,600 V (1,200 V for UR80)	<b>81</b> <b>82</b>	
13	Application	Fixed Installation	<b>S</b>	<b>S</b>
14	Arc chute installation (Refer to page 7 for selection)	Opening on LV connector side Opening on LV connector opposite side Vertical removal	1 7 8	
15	Control type	Electric holding - without ECO-Drive Magnetic holding - without ECO-Drive Electric holding - with ECO-Drive (1)	E M 4	
16	Nominal supply voltage	110 V <sub>DC</sub> 125 V <sub>DC</sub>	E R	
17	Varistor in coil (2)	No Yes (battery voltage)	0 1	
18	Direct overcurrent release (bidirectional)	1.4 - 2.7 kA 2.0 - 8.0 kA 4.0 - 15.0 kA 14.0 - 18.0 kA 18.0 - 24.0 kA .....	A D F L P W	
19	Indirect release (shunt trip)	Direct overcurrent release (unidirectional) - UR60/80 UR26/40/46 (includes horizontal manual release) UR26/40/46 (includes horizontal manual release) UR60/80 (includes horizontal manual release) UR60/80 (includes horizontal manual release)	BIM5 BIM6 BIM7 BIM8	5 7 4 6
20	Auxiliary contacts	5a + 5b - (switch PF) 5a + 5b - (switch CO)	A B	
21	LV connector type on circuit breaker	No Harting type HAN® 32 EE	0 C	
22	Manual release	No Horizontal Vertical	0 1 2	
23	Manual closing device (not compatible with line 25 nor 26)	No Yes	0 2	
24	Position indicator	No Yes	0 3	
25	Overcurrent release detector (not compatible with line 23 nor 26)	No Yes	0 1	
26	Contact wear indicator (not compatible with line 23 nor 25)	No Yes	0 1	
27	HV main connections (according to pages 6)	Standard	S B	
28	Digit for Sécheron internal purpose	Arc chute 81 & 82 Arc chute 81 & 82	Q P	

(1) ECO-Drive is only available for UR26/40/46 with Harting HAN® 32 connector and 110V<sub>DC</sub> control voltage.  
 (2) In case control type "Electric holding with ECO-Drive is selected (line 15), select "No" for Varistor on Coil (line 17)

The low voltage connector must be ordered separately:  
 Harting type HAN® 32 EE:  SG104063R10100

Value of the setting of maximum current release value (Id): .....[A]



**Sécheron SA**  
 Rue du Pré-Bouvier 25  
 1242 Satigny - Geneva  
 CH-Switzerland

**www.secheron.com**  
 Tel: +41 22 739 41 11  
 Fax: +41 22 739 48 11  
 ess@secheron.com

Signature:

Name:

Place and date: