

ROOF DISCONNECTOR

Type **RS**

RAIL VEHICLES

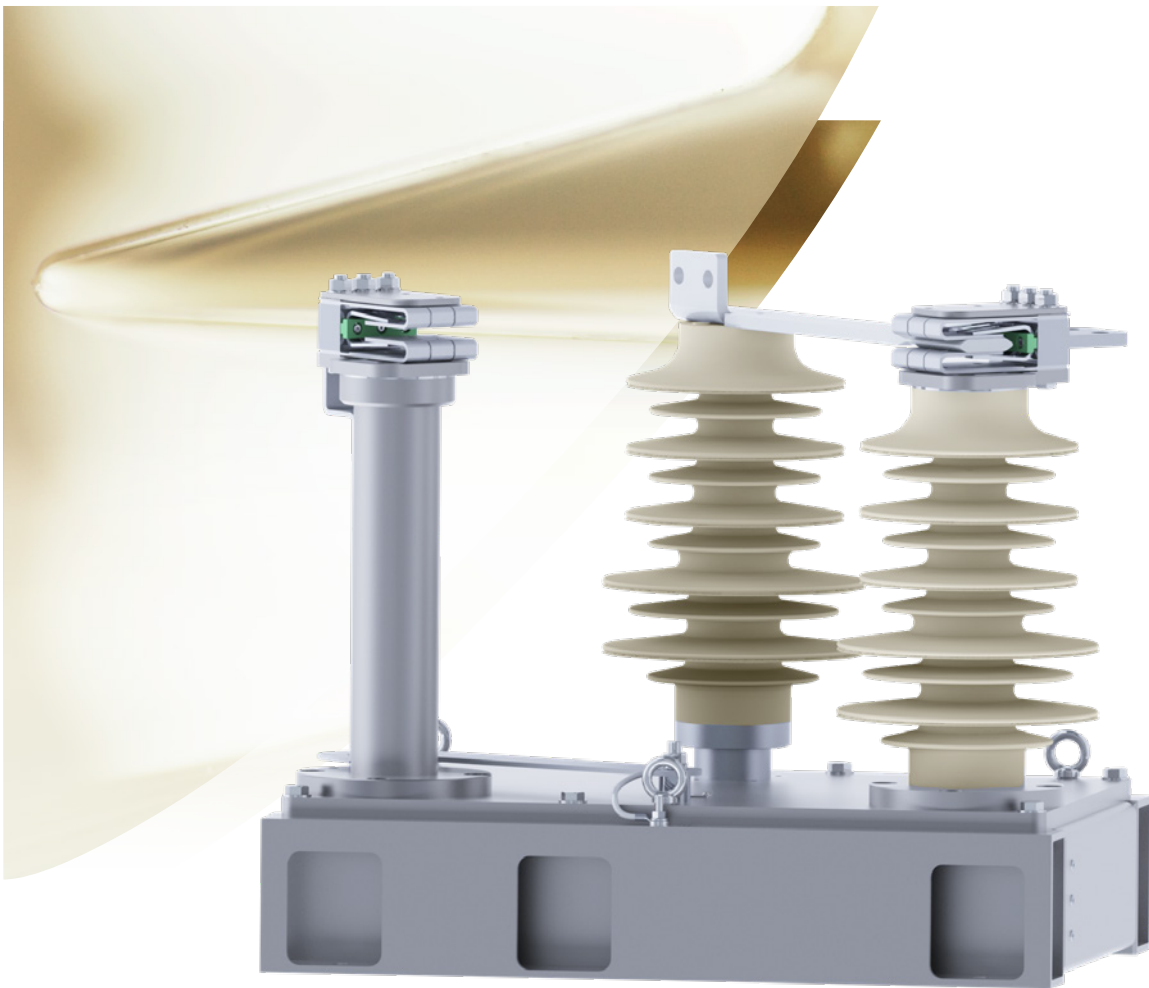

GENERAL INFORMATION

Sécheron **RS**-type roof-mounted disconnectors are known by rail car builders, traction propulsion equipment manufacturers, and train operators for their performances, reliability, and low maintenance.

Our RS disconnector offers a wide range of configurations and options to meet the needs of most railway applications. Our product range includes pantograph disconnector with or without earthing,

AC/DC voltage selector for multi-system vehicles, and roof line disconnector.

Our disconnector can be delivered on a stand-alone basis, or integrated into a MACS AC circuit breaker on a specific project basis. A specific indoor version can be delivered into Sécheron compact MODBOX® high-voltage integrated enclosure, with other high- and low-voltage functions.

APPLICATION

AC/DC typical application

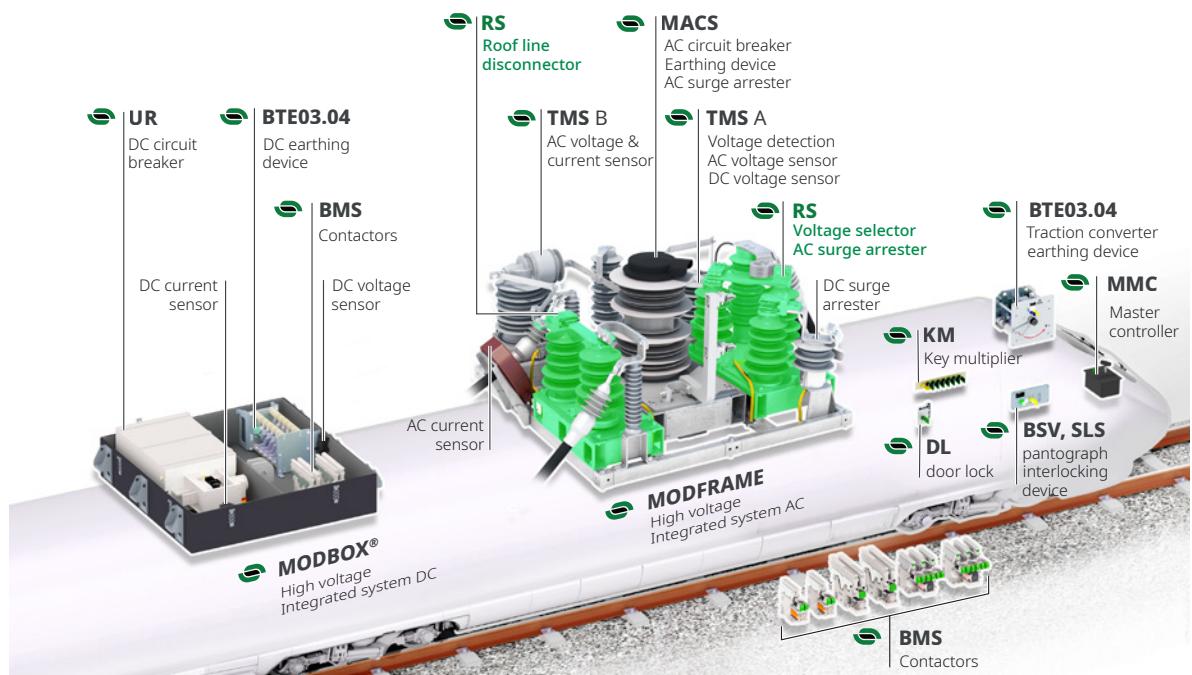

MAIN FEATURES

- Rated operational voltage up to 3.6 kV_{DC} or 27.5 kV_{AC}.
- Rated free air thermal current from 1,000 A to 4,000 A.
- Usable in various ranges of ambient temperature from -40°C to +70°C for electric version (-50°C to +70°C in option).
- Reference standards: EN/IEC 60077-1/-2; EN/IEC 61373; EN 50124-1/IEC 62497-1; EN 45545-2.

MAIN BENEFITS

- ✓ A comprehensive product lineup
- ✓ A wide range of configurations and options
- ✓ Standard and custom solutions
- ✓ High insulation level, OV3 and OV4 categories
- ✓ High rated short-time withstand current to ensure a safe protection's coordination with the vehicle's main circuit-breaker performances
- ✓ Suitable for vehicle speed up to 380 km/h (when installed outdoor).
- ✓ Specific execution to eliminate the need for roof cut-out
- ✓ Extensive factory reliability testing
- ✓ Low maintenance & low Total Cost of Ownership

PRODUCT RANGE

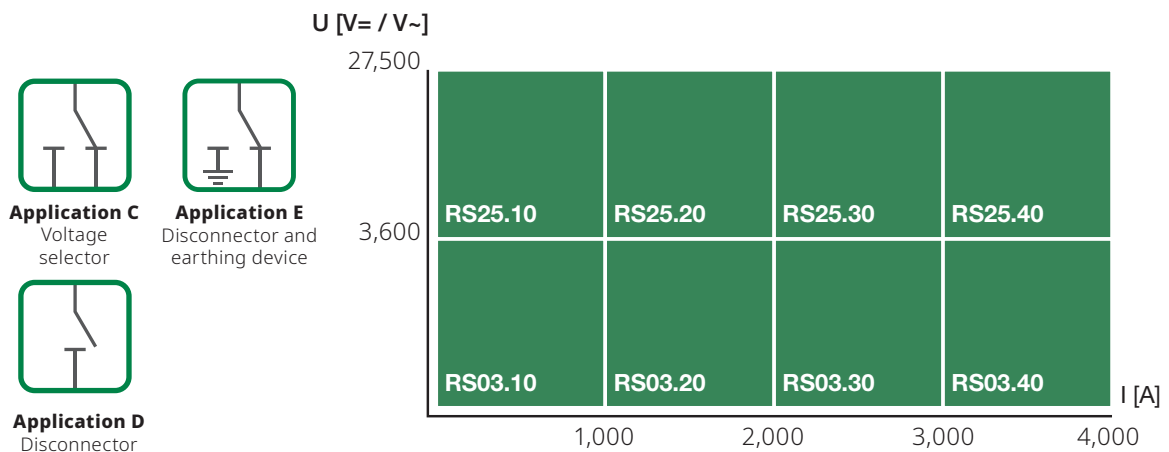

DATA FOR PRODUCT SELECTION

	Symbol	Unit	RS 25.10	RS 25.20	RS 25.30	RS 25.40	RS 03.10	RS 03.20	RS 03.30	RS 03.40	
MAIN HIGH VOLTAGE CIRCUIT											
Rated operational voltage	U_e	[kV _{AC}] [kV _{DC}]	27.5 -	27.5 -	27.5 -	27.5 -	- 3.6	- 3.6	- 3.6	- 3.6	
Rated frequency	f	[Hz]	16.7 50/60	16.7 50/60	16.7 50/60	16.7 50/60	-	-	-	-	
Rated insulation voltage	U_i	[V _{AC}] [V _{DC}]	27.5 -	27.5 -	27.5 -	27.5 -	- 4.8	- 4.8	- 4.8	- 4.8	
Conventional free air thermal current ⁽¹⁾	I_{th}	[A]	1,000	2,000	3,000	4,000	1,000	2,000	3,000	4,000	
Peak and rated short-time withstand current AC:	\hat{I}_{cW}	[kA _{AC}]	63	63	63	63	-	-	-	-	
	I_{cW}	[kA _{AC}]	25	25	25	25	-	-	-	-	
	t	[s]	1	1	1	1	-	-	-	-	
	DC:	\hat{I}_{cW}	[kA _{DC}]	63	70	70	70	63	70	70	70
		I_{cW}	[kA _{DC}]	44	50	50	50	44	50	50	50
	t	[s]	0.1	0.1	0.1	0.1	0.1	0.1	0.1	0.1	
Overvoltage category			OV3 or OV4				OV4				
- Pole-Pole			OV4				OV4				
- Pole-Earth			OV4				OV4				
Rated power-frequency withstand voltage ⁽²⁾	U_{50}	[kV _{rms}]	80				20				
Rated impulse withstand voltage (1.2/50 μs)	U_{imp}	[kV]	125 (OV3) or 170 (OV4)				40				

⁽¹⁾ At Tamb = +40°C and tested with high voltage connections according to standard IEC/EN 60943. • ⁽²⁾ At 50 Hz during 1 minute: Pole-Pole; main circuit-earth.

LOW VOLTAGE AUXILIARY CIRCUIT

Control circuit

Type of operation			Electric or electro-pneumatic							
Nominal Supply voltage	U_n	[Vdc]	24, 36, 48/50, 72, 110							
Range of voltage			[0.7-1.25] U_n							
Electric version:										
- Control power ⁽³⁾	P	[W]	125							
Electro-pneumatic version:										
- Control power ⁽³⁾	P	[W]	2.5							
- Air flow (per operation)		[l]	0.4							
- Operating air pressure ⁽³⁾	P	[MPa]	0.4 - 1							
Commutation time ⁽³⁾		[s]	≤ 3 (RS..10/RS..20)							
		[s]	≤ 6 (RS..30/RS..40)							

⁽³⁾ At U_n and Tamb = +20°C

Auxiliary contacts

Type of contacts			Changeover (CO)							
Rated voltage		[V _{DC}]	24 to 110							
Conventional thermal current	I_{th}	[A]	10							
Switching categories according to EN 60947 (silver contacts)										
- AC-15			<230 V _{AC} 1.0 A							
- DC-13			110 V _{DC} 0.5 A							
Minimum let-through current at 24 Vdc ⁽⁴⁾		[mA]	≥ 10 (silver contacts) or 4 ≤ I < 10 (gold contacts)							

⁽⁴⁾ For a dry and clean environment.

Low voltage interface

Type of connection ⁽⁵⁾			Harting HAN 24 DD							
-----------------------------------	--	--	-------------------	--	--	--	--	--	--	--

⁽⁵⁾ Refer to page 7 for mobile connector informations.

Insulation

Rated power-frequency withstand voltage ⁽⁶⁾	U_{50}	[kV _{rms}]	1.5							
--	----------	----------------------	-----	--	--	--	--	--	--	--

⁽⁶⁾ At 50 Hz during 1 minute.

OPERATING CONDITIONS

Installation			Outdoors							
Altitude		[m]	< 2,000 ⁽⁷⁾							
Working ambient temperature										
- Electric operation	T_{amb}	[°C]	-40 to +70 (-50 to +70 in option)							
- Electro-pneumatic operation	T_{amb}	[°C]	-25 to +70							
Humidity			According to EN/IEC 62498-1/EN 50125-1							
Pollution degree			PD4							
Minimum mechanical durability	N	Cycles	≤ 250,000							
Protection index:										
- HV part			IP00							
- LV part			IP4X							
- Tightness between upper and lower part when installed ⁽⁸⁾			IP65							

⁽⁷⁾ For >2,000 m, please contact Sécheron. • ⁽⁸⁾ Delivered with an O-ring seal.

PRODUCT INTEGRATION

MAIN DIMENSIONS (STANDARD VERSION)

HV connections	M12 screws
Earth connections	M10 screws

Dimensions without tolerance are indicative. All dimensions are in mm. The maximum allowed flatness deviation of the support frame is 1 mm.

Applications D (RS..10, RS..20)

OV3: RS25../OV4: RS03..

	RS..10	RS..20
	D	D
A	550	550
B	280	280
C	413	424
E-RS25	425	444
E-RS03	239	258
F	247	231
G	462	486

Applications D/Applications C and E (RS..30, RS..40) (RS..10 to RS..40)

OV3: RS25../OV4: RS03..

	RS..30	RS..40
	D	D
A	605	605
B	386	386
E-RS25	444	454
E-RS03	258	268
F	234	234
H-RS25	655	715
H-RS03	655	698
K-RS25	431	431
K-RS03	397	397

RS..10	RS..20	RS..30	RS..40
C/E	C/E	C/E	C/E
605	605	605	605
386	386	386	386
425	444	444	454
239	258	258	268
247	234	234	234
657/631	669/631	706/675	773/736
645/625	669/637	706/675	773/736
431	431	431	431
397	397	397	397

OV4: RS25..

	RS..10	RS..20
	D	D
A	630	630
B	280	280
C	493	504
E	425	444
F	327	311
G	542	566

OV4: RS25..

	RS..30	RS..40
	D	D
A	713	713
B	440	410
E	444	454
F	310	310
H	763	823
K	485	485

RS..10	RS..20	RS..30	RS..40
C/E	C/E	C/E	C/E
713	713	713	713
440	440	440	440
425	444	444	454
323	310	310	310
765/739	777/745	814/783	881/844
485	485	485	485

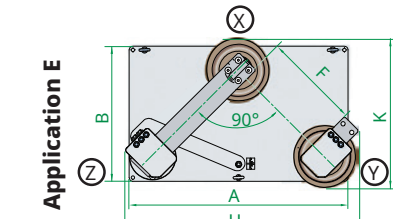
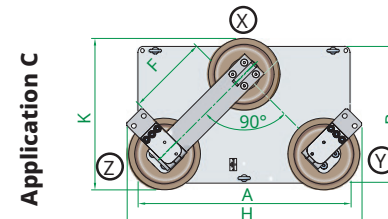
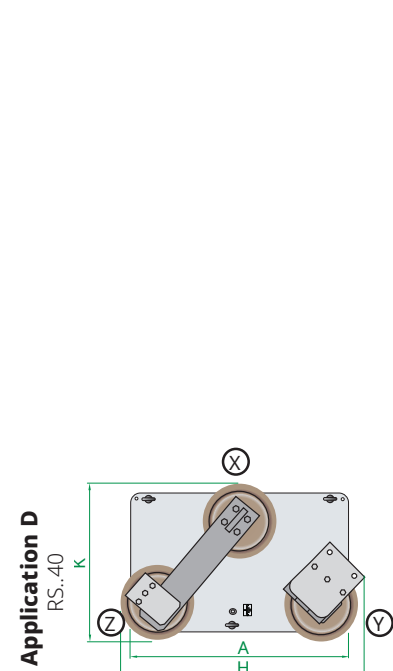
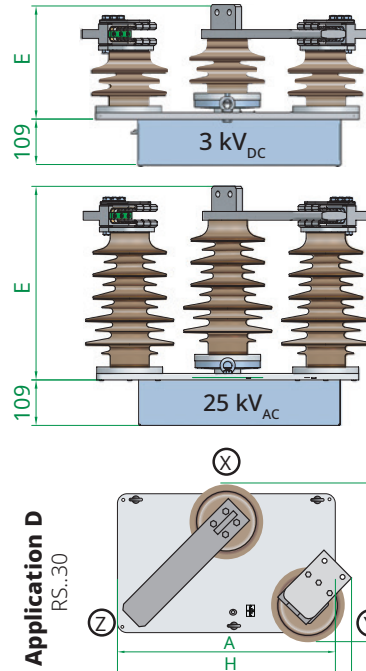
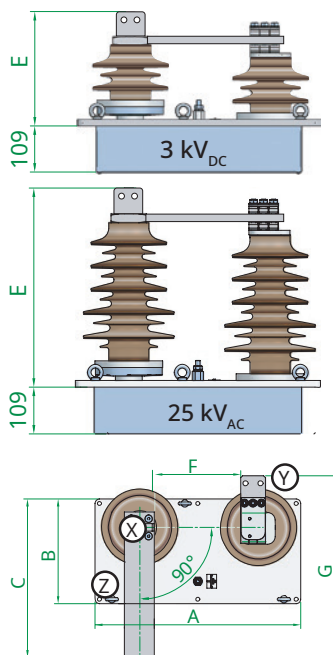

VEHICLE ROOF CUT-OUT REQUIREMENTS

For version without roof cut-out refer to page 10.

APPLICATION D

RS..10, RS..20
Dimensions

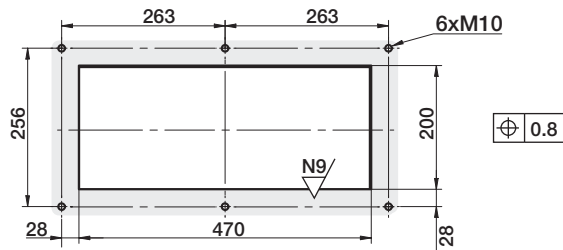

For dimensions A x B = 550 x 280 mm

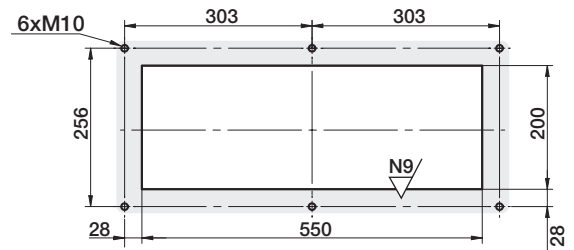

For dimensions A x B = 630 x 280 mm

APPLICATIONS C and E

RS..10, RS..40

APPLICATION D

RS..30, RS..40

Dimensions

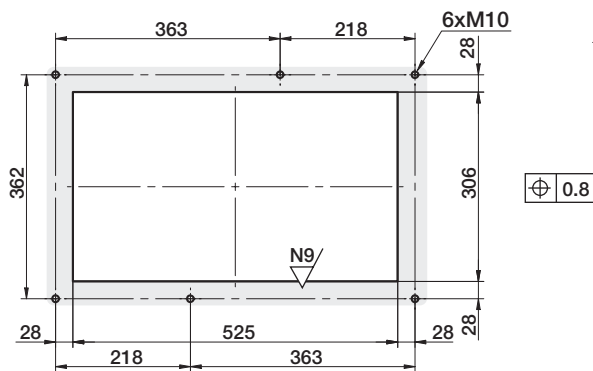

For dimensions A x B = 605 x 386 mm

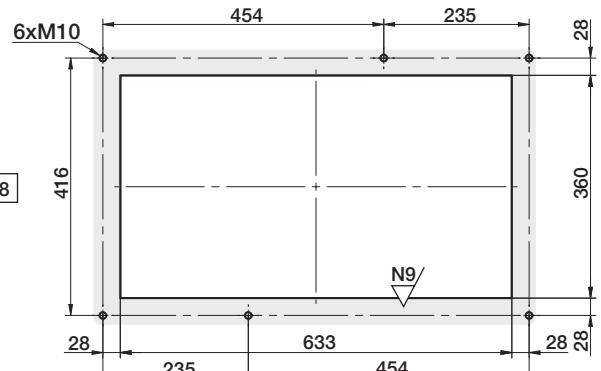

For dimensions A x B = 713 x 440 mm

WEIGHT IN KG (± 3 KG)

		RS25.10		RS25.20		RS25.30		RS25.40	RS03.10				RS03.20		RS03.30		RS03.40			
		OV3	OV4	OV3	OV4	OV3	OV4	OV4	OV4	OV4	OV4	OV4	OV4	OV4	OV4	OV4	OV4			
APPLICATION	C	48	51	54	57	56	59	67	37	43	45	53	29	34	39	52	34	41	43	51
	D	37	39	39	42	45	48	66												
	E	44	47	49	53	51	55	63												

Note. For the weight of the pneumatic version please contact Sécheron.

POLES CONFIGURATION

STANDARD

Application D
(RS..10, RS..20)

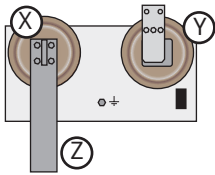

Application D
(RS..30)

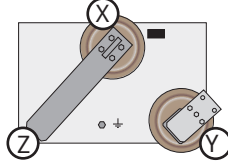

Application C
(RS..10 to RS..40)

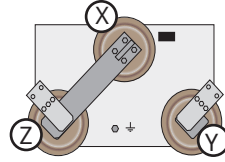

Application E
RS..10 to RS..40)

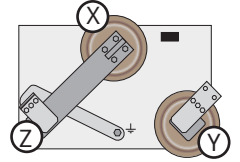

Application D
(RS..40)

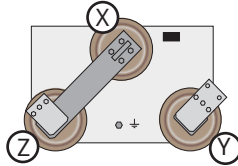

ALTERNATIVE

Application D
(RS..10, RS..20)

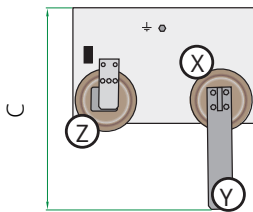

	RS25.10	RS25.20
C (OV3)	541	552
C (OV3)	621	632

Application D
(RS..30) ⁽¹⁾

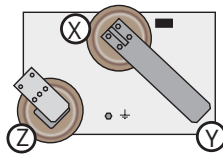

Application D
(RS..40) ⁽¹⁾

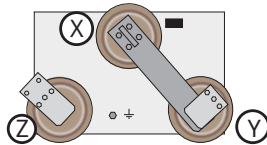

Application E
(RS..10 to RS..40) ⁽¹⁾

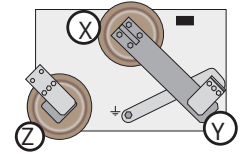

⁽¹⁾ Overall dimensions are identical to standard version.

LOW VOLTAGE WIRING INTERFACE



Electric version

Harting type
HAN 24DD

Note. Low voltage connectors are delivered with all pins mounted.

LOW VOLTAGE CONTROL DIAGRAM FOR ELECTRIC AND ELECTRO-PNEUMATIC VERSION

ELECTRIC VERSION

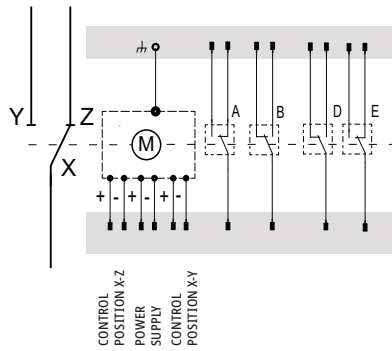

ELECTRO-PNEUMATIC VERSION (OPTION)

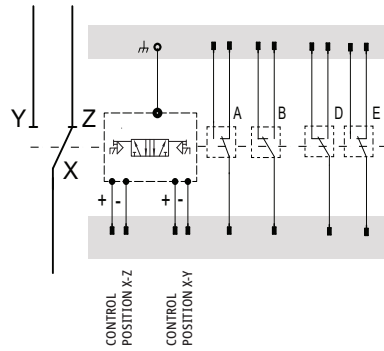

The represented control diagrams are for standard electric version and optional electro-pneumatic version of the voltage selector with standard pole configuration.

For other configurations as well as for the low voltage wiring scheme corresponding to your configuration, please contact Sécheron.

Legend

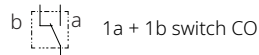
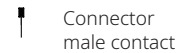
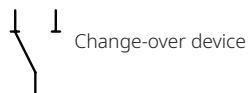

OPTIONS

(SUBJECT TO ADDITIONAL COSTS)

ELECTRO-PNEUMATIC OPERATION (RS..10, RS..20, RS..30)

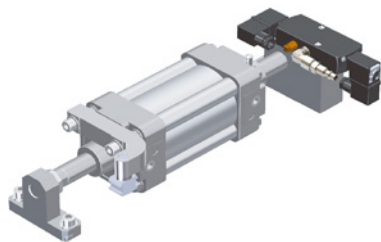

The electro-pneumatic drive fits in the same volume as the electric drive. The customer's air circuit is connected directly into the G1/4" L-connection of the cylinder valve, by means of a quick release air connection (to be ordered separately - refer to page 7).

HIGH VOLTAGE CONTACT - ICE PROTECTION

(RS..10, RS..20, RS..30 AND RS..40)

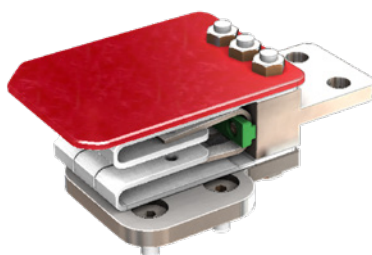

Assembled on the top of the fixed contacts, this protection limits the impact of icing conditions on the RS functionality.



add silicon chapter with

LOW VOLTAGE MOBILE CONNECTOR



(DESIGNATION CODE FOR SEPARATELY ORDERED ITEMS)

RS configurations			Mobile connectors					
Auxilliary Switches		Fixed connector type	Type	Number of pin		Cable gland	Cable entry	Secheron's reference
Number	Type			Size 2.5 mm ²	Size 1.5 mm ²			

Electric version configuration without optional roof box



2a + 2b	CO	Harting HAN® 24 DD	Harting HAN® 24 DD	7	7	PG21		SP1850005R00003
4a + 4b	CO	Harting HAN® 24 DD	Harting HAN® 24 DD	7	13	PG21		SP1850005R00004

Electric version configuration with optional roof box

2a + 2b	CO	Harting HAN® 6HPR 24	Harting HAN® 6HPR 24	7	7	PG21		SP1850085R00021
4a + 4b	CO	Harting HAN® 6HPR 24	Harting HAN® 6HPR 24	7	13	PG21		SP1850085R00022

Reduce this

Electro-pneumatic version

2a + 2b	CO	Harting HAN® 24 DD	Harting HAN® 24 DD	0	13	PG21		SP1850085R00021
4a + 4b	CO	Harting HAN® 24 DD	Harting HAN® 24 DD	0	19	PG21		SP1850085R00022

PNEUMATIC CONNECTION



Quick release air connection for the pneumatic operation.

Type PARKER PB 52 with pipe 8x1

Sécheron's number: **SP1850009R00001**.

The air connection must be ordered separately.

ROOF BOX FOR VEHICLE WITHOUT ROOF CUT-OUT

In most cases, installation of the RS on a vehicle requires to cut-out the roof so that the RS low-voltage part can be protected under the vehicle roof, while the high-voltage part is above the roof.

To avoid such roof cut-out, the RS switch can be delivered together with a roof box to protect the low-voltage part

when installed above the roof. RS roof box structure is validated according to EN 12663 and features a protection index IP65. The complete set RS and roof box is validated for vibrations and shocks according to EN/ IEC 61373.

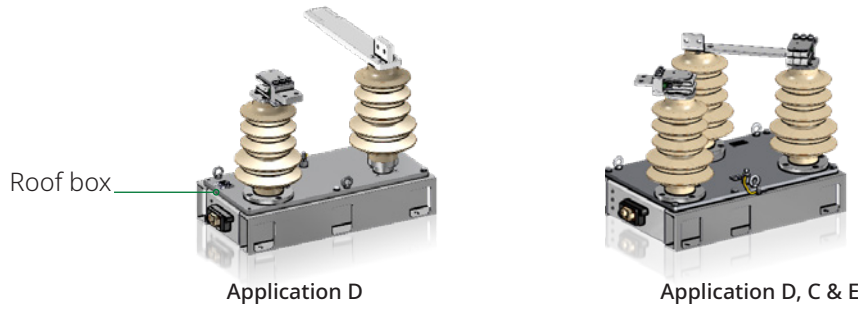

The RS roof box execution is only available for electric operation.

MAIN DIMENSION

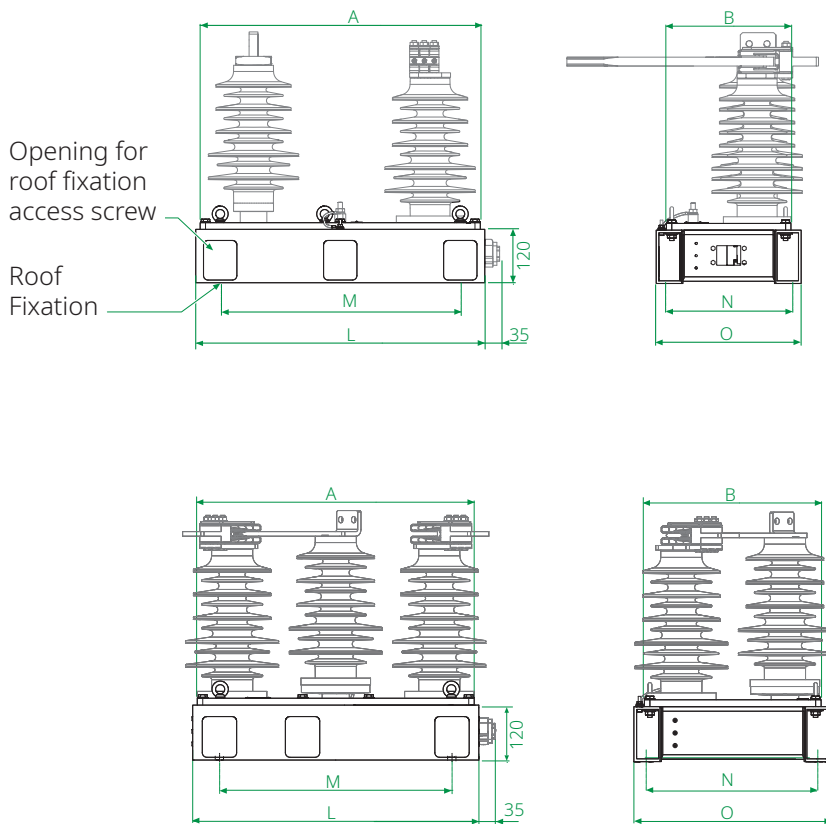

APPLICATION D

Dimensions

		Application D RS..10, ..20	
		OV3	OV4
Base plate	A (mm)	550	630
	B (mm)	280	280
Roof box	L (mm)	570	650
	M (mm)	460	540
	N (mm)	326	326
	O (mm)	280	280

APPLICATION D, C & E

Dimensions

		Application D RS..30, ..40		Application C & E RS..10, ..40	
		OV3	OV4	OV3	OV4
Base plate	A (mm)	605	713		
	B (mm)	386	440		
Roof box	L (mm)	625	733		
	M (mm)	508	616		
	N (mm)	432	486		
	O (mm)	386	440		

WEIGHT FOR ELECTRIC VERSIONS WITH R IN KG (± 3 KG)

		RS25.10		RS25.20		RS25.30		RS25.40	RS03.10				RS03.20	RS03.30	RS03.40
		OV3	OV4	OV3	OV4	OV3	OV4	OV4	OV4	OV4	OV4	OV4	OV4	OV4	OV4
APPLICATION	C	56	62	62	68	64	70	78	45	51	53	61			
	D	43	46	45	49	51	55	73	35	40	45	58			
	E	52	58	57	64	59	66	64	42	49	51	59			

SILICON INSULATORS

As customized solution, Sécheron is offering to replace standard Epoxy Resin Insulators with Silicon Insulators.

Main advantage is these Silicon Insulators are less sensitive to solid impact and so to wing damages.

If you have interest for these, please ask your Sécheron contact about.

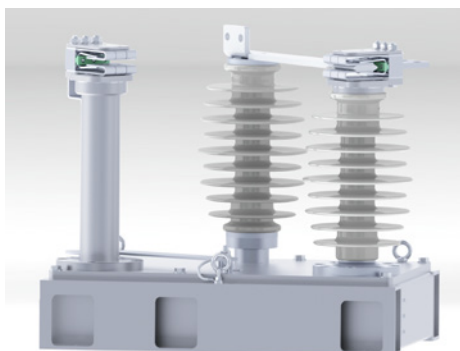

The 25 kV Silicon RS has compact height in order to keep same height as 25kV Current Epoxy Resin RS.



The 3 kV Silicon RS is higher of 32 mm compared to 3 kV Current Epoxy Resin RS.

DATA FOR PRODUCT SELECTION

- Be sure to establish the designation code from the latest version of our brochure by downloading it from the website: www.secheron.com.
- Be careful to write down the complete alphanumerical designation code with 18 characters when placing your order.
- For technical reasons some variants and options indicated in the designation code might not be combined, therefore validate your configuration with Sécheron before ordering.
- For other configurations not described in the brochure, please contact Sécheron.
- The bold characters of the designation code define the device type

Example of customer's choice:	RS	25	20	C	S	4	C	E	3	A	1	1	S	0	1
Line:	10	11	12	13	14	15	16	17	18	19	20	21	22	23	24

DESIGNATION CODE

Line	Description	Designation	Standard	Options	Customer's choice
10	Product type	RS	RS		RS
11	Rated operational voltage	up to 3.6 kV _{DC} up to 27.5 kV _{AC}	03 25		
12	Rated conventional free air thermal current	1,000 A 2,000 A 3,000 A 4,000 A	10 20 30 40		
13	Application	Voltage selector Disconnecter Disconnecter with earthing	C D E		
14	Pole configurations	standard (only for application D and E) Alternative	S	A	
15	Overvoltage category between poles	(RS25.. and RS03..) OV4 (RS25.. only) OV3	4 3		
16	Operation	Electric Electro-pneumatic ⁽¹⁾	E	P	
17	Nominal supply voltage	24 V _{DC} 36 V _{DC} 48/50 V _{DC} 72 V _{DC} 110 V _{DC}	A B C D E		
18	Auxiliary contacts	2a + 2b - (switch CO) - silver type 2a + 2b - (switch CO) - gold type 4a + 4b - (switch CO) - silver type 4a + 4b - (switch CO) - gold type	1	2 3 4	
19	Low voltage connector	Harting connector type HAN 24 DD (for roof box execution) Harting HAN 6HPR 24	A	B	A
20	Low voltage protecting cover	For version with roof box For version without roof box	1	∅	
21	Control equipment	(Electro-pneumatic version) Not applicable (Electric version) Integrated	Z 1		
22	Roof execution	Roof opening No roof opening (roof box) ⁽²⁾	S	R	
23	HV contacts protection	No Ice protection	∅	1	
24	Ambient temperature range	(Electric version) -40°C to +70°C (Electric version) extended to -50°C to +70°C (Electro-pneumatic version) -25°C to +70°C	1	2 3	

⁽¹⁾ Only valid for RS..10, RS..20, RS..30 • ⁽²⁾ Only for electric operation

The low voltage mobile connector and air connection must be ordered separately (refer to page 9).

Electric version without roof box: SP1850005R00003 SP1850005R00004

Electric version with roof box: SP1850085R00021 SP1850085R00022

Electro-pneumatic version: SP1850005R00001 SP1850005R00002 Air connection: SP1850009R00001



Sécheron SA
Rue du Pré-Bouvier 25
1242 Satigny - Geneva
CH-Switzerland

www.secheron.com
Tel: +41 22 739 41 11
Fax: +41 22 739 48 11
ess@secheron.com

Signature:

Name:

Place and date: